

TRACTION BATTERIES TECHNICAL DATA

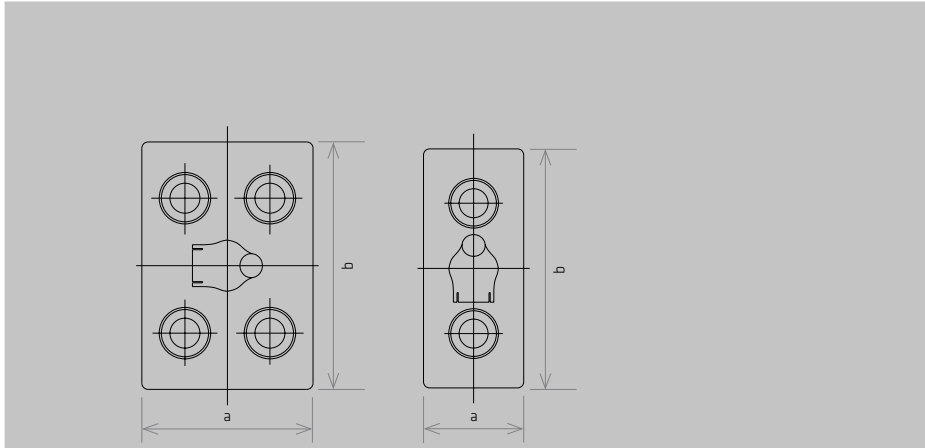



WE PRODUCE BATTERIES / CELLS IN WELDED AND BOLTED VERSION



In order that the batteries would meet all your demands, we kindly ask you to enclose the following data with your order:

- + battery **voltage**
- + **capacity** of the battery at a five-hour discharge rate
- + **dimensions** of the battery tray
- + **design and type** of the electric machine
- + any **special demands**
- + a battery **drawing** (when possible)

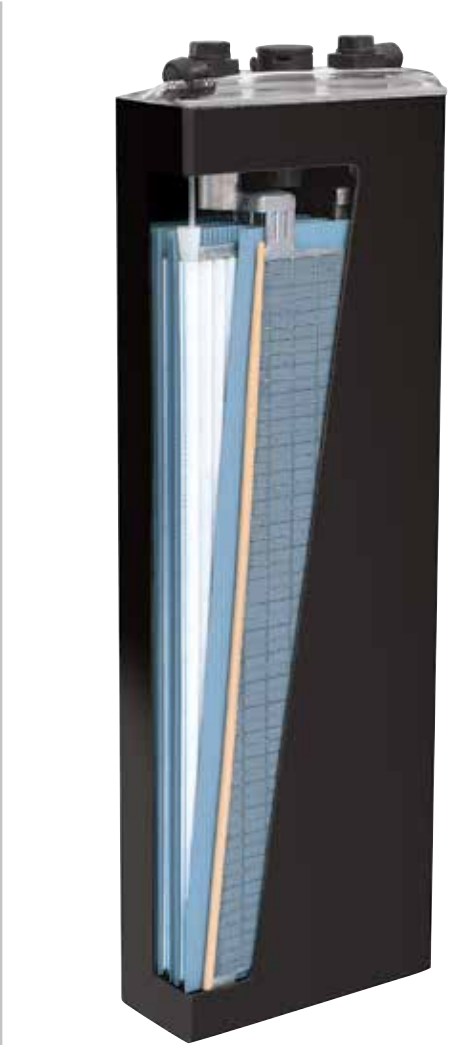

All measures and weights are within standard production tolerances.
Electrical values are approximate.
Technical modifications are reserved without prior notice.

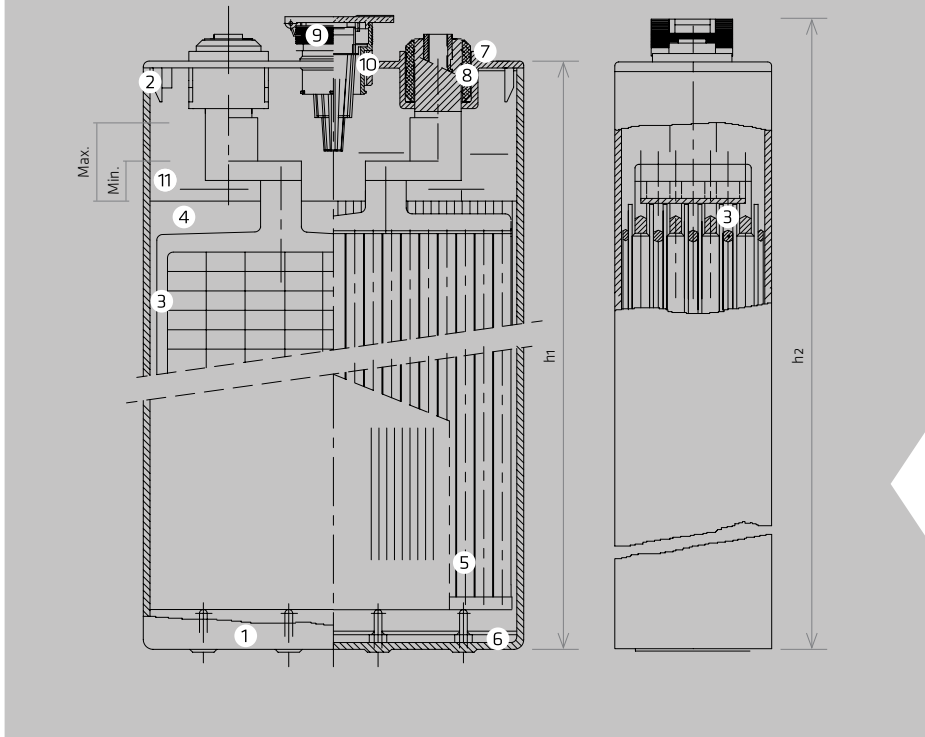

- 1 Polypropilene container
- 2 Polypropilene cover
- 3 Negative grid Plate
- 4 Microporous separator
- 5 Positive armoured tube Plate
- 6 Settling rib
- 7 Terminal post
- 8 Rubber sealing
- 9 Cell plug Ø35,5
- 10 Plug sealing Ø35,5
- 11 Electrolyte

ADVANTAGES OF TAB TRACTION BATTERIES

More than 50 years of experiences in battery manufacturing



MORE THAN 100 YEARS LONG HISTORY

- + Batteries manufactured according to requirements of the management system standard ISO 9001:2008 (year 1995) and ISO 14001 (year 1998).
- + Wide production program covers the range of DIN (EPzS) and BS (PzB) cells
- + Cells are produced and tested according to EN/IEC 60 254-1,2
- + TAB Traction batteries are appropriated for propulsion of different electrical machines (forklifts, cleaning machines, wheelchairs, ...)
- + Batteries are known by their high capacity, long life and simple maintenance
- + Plates are produced on latest and world leading manufacturing machinery
- + The cells are designed to produce more capacity for longer run times and battery life with optimized active material density of the positive plates
- + Use of PE separator with low internal resistance and with high mechanical characteristics to prevent short circuits
- + Additionally minimized risk of side-short circuits with use of gauntlets with resin side protection for positive plates
- + Improved design of pole posts with robust construction and higher corrosion stability
- + Tinned surface protection of brass insert for bolted types reduces voltage drops and increases corrosion resistance of the insert
- + Batteries can be assembled in bolt-on or welded design
- + Steel trays for the batteries are made in according to highest standards and completely protected against corrosion with PE layer
- + Batteries could upon an order be equipped with following additional systems:
 - EUW – Electrolyte mixing system which allows an electric forklift to run in heavy duty operation. Charging time could be reduced with used higher initial current, charging factor could be reduced, lower charging and operating temperatures, reduced water consumption and longer expected life
 - Central Water Filling System which enables a quick and precise service of the whole battery under any working conditions
 - Capacitive battery electrolyte level sensor with clearly visible green light indicates electrolyte at proper specified level. Flashing red light indicates that the electrolyte level is below minimum and battery needs to be refilled with demineralised water to avoid permanent damage of the battery.

ADVANTAGES OF TUBULAR POSITIVE PLATES

- + Polyester gauntlets are fixed by acrylic resin
- + Half of outside tubes are covered with additional resin to prevent side short circuits
- + Tubular design keeps the active material mechanically together and presses it onto the grid and thus prevents shedding of active material due to forklift vibrations
- + The tube with the circular cross section avoids shedding of the mass and keeps the structure together
- + Corrosion speed is reduced by the tubes, because pressing the PbO_2 corrosion layer onto the grid surface and helps to protect the lead grid against further corrosion
- + The tubular grid needs no horizontal bars, which reduces lead weight and avoids growing of the grid in the width
- + The flat plate battery is typically 15% heavier than the tubular and consequently the flat plate battery bears higher costs
- + Tubular plates could be produced by dry filling or wet-paste filling with uniform mass density
- + For bridging times of 1h and longer, tubular plate batteries are more economical
- + Tubular batteries have lower corrosion behavior due to the tubular design and also due to the different casting technique
- + The tubular grids are casted with a 110 -130 bar pressure unit, thus avoiding voids and cracks nearly completely
- + Batteries with tubular plate design have excellent deep cycling performance
- + Expected life is 20% higher as flat plate
- + Tubular batteries reach more than 1500 cycles at 80% DOD according to EN/IEC 60 254-1

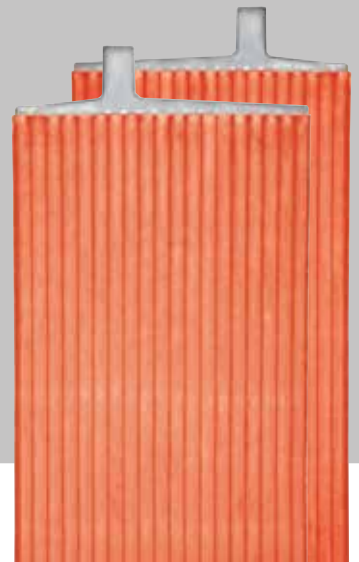

ASSEMBLY AND OPERATING INSTRUCTIONS

for TAB Traction batteries with air mixing system

PRINCIPLE OF ELECTROLYTE AIR MIXING SYSTEM.

This optional system is recommended for heavy duty use, short charge times, boost or opportunity charging and in case of use at high ambient temperatures. The system reduces water consumption, working temperatures and a charge factor, prevents the stratification of the electrolyte and reduces charging time. When a battery is charged, concentrated sulphuric acid is formed. In comparison

with "normal acid", concentrated sulphuric acid is heavier, and sinks towards the bottom of the cell, resulting in acid stratification. To avoid this stratification the air is introduced into the battery right at the main charging stage. The rising air bubbles circulate the electrolyte, thereby preventing stratification of the acid. In comparison with other mixing methods, mixing of the acid by in-blown air gives the greatest efficiency.



aquamatic

PzS TAB CELL TYPE DIN

Cell Type	Ah/Plate (Ah)	BFS floater type (mm)
Pg 190 L	50	20
Pg 250 L	60	20
Pg 310 L	80	20
Pg 360 L	90	29
Pg 425 L	105	29
Pg 425 S	105	34
Pg 445 L	115	34
Pg 445 S	115	34
Pg 480 L	125	34
Pg 530 S	130	39
Pg 555 L	140	34
Pg 555 S	140	39
Pg 590 L	155	39

PzB TAB CELL TYPE BS

Cell Type	Ah/Plate (Ah)	BFS floater type (mm)
Pgi 135	23	14
Pgi 190	32	14
Pgi 250	42	14
Pgi 310	55	24
Pgi 360	65	29
Pgi 413	75	34
Pgi 450	86	34
Pgi 492	100	34
Pgi 530	108	39



ASSEMBLY AND OPERATING INSTRUCTIONS

for TAB Traction batteries with capacitive battery electrolyte level sensor



The biggest problem in battery maintenance is knowing when to fill the batteries with water. Without indication, operators often need to devise watering schedules or carry out periodic inspections to maintain the batteries. Time is often wasted when inspecting and topping up batteries that do not require filling, while batteries left under-filled can suffer costly permanent damage.

Electrolyte level sensor/system battery watering monitor will simplify battery watering by only topping batteries when required; no schedule is needed and less time is wasted.

The red and green indicator ensures that mistakes are not made by the operator, and the smart technology eliminates batteries drying out due to false signals.



The principle of the electrolyte circulation system is based on air pumping into the each battery cell which creates a circulating air stream inside the cell box so ensure that the charger belonging to the battery is designed for electrolyte circulation.

The charge plug with integrated air supply automatically supplies air to the battery pipe system after connecting to the charger designed for electrolyte circulation.

For optimized operation the pump should supply pressure around 0,2 bar and air flow 60 liters/cell,hour. Only purified air may be supplied to the cells.

This is to be ensured by means of a suitable filter.

Before initial operation of battery with electrolyte circulation system make a visual examination of the electrolyte surfaces of all cells for movement and rising air bubbles during running the air pump.

At least once a year, the pump air filter must be changed. In work areas with high level of air pollution, the filter should be checked and replaced more frequently to assure proper air circulation.

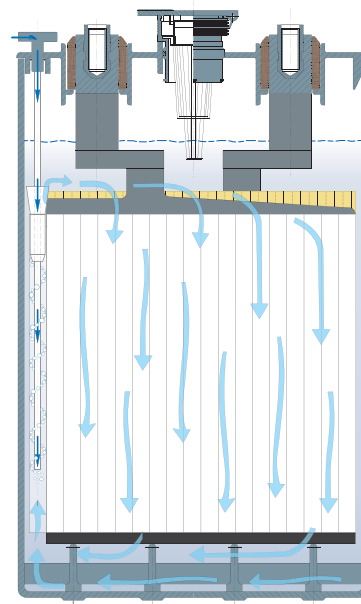

airmatic

ASSEMBLY AND OPERATING INSTRUCTIONS for TAB Traction batteries with aquamatic water refilling system

Optional water refilling system built on batteries is used to automatically maintain the nominal electrolyte levels. The battery should be topped up shortly before completion of a full charge with water with the conductance below 30 $\mu\text{S}/\text{cm}$. The battery should be connected to the filling system at least once a week. In multiple shift and warm ambient temperature operations, it may be necessary to have shorter-daily topping up intervals.

In winter, batteries fitted with Aquamatic system should only be charged or refilled in a room temperature above 0 °C. For proper water pressure and optimal system operation, the water tank must be located from 2 to 6 m above the upper edge of the battery (0,2 to 0,6 bar). The top up process takes a few minutes and can vary according to the battery range. The valve in each cell allows the flow of water into cell and the float closes the valve when the correct water level has been reached. A flow

indicator built into the water supply pipe to the battery monitors the filling process. During filling the water flow causes the flow indicator to turn. When all the plugs are closed the integrated disc stops, indicating that the filling process is complete, the water supply to the battery should be turned off. **Regularly clean integrated water filter! The system installed by the producer should not be modified in any way.** Option also for central degassing system.



level sensor

CHARGING OF TRACTION FLOODED BATTERIES ACCORDING TO DIN 41773 AND 41774 AND ZVEI RECOMMENDATION

Wa characteristic (taper) for flooded batteries

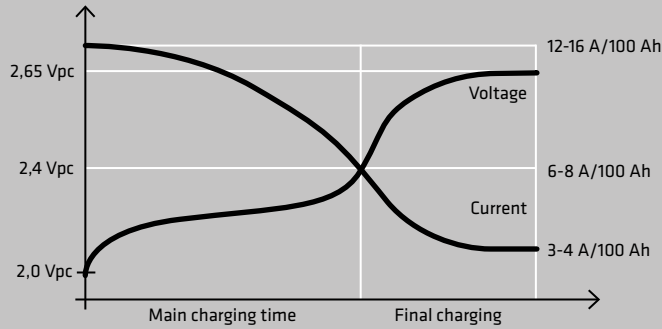

Charging times with Wa characteristics in hours for PzS batteries at 30 °C

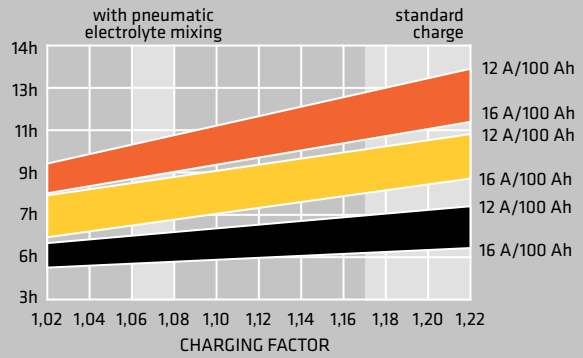

WaWO (double slope taper) characteristic for flooded batteries

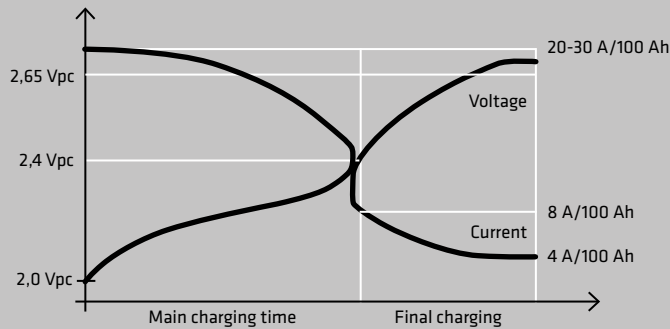

Charging times with WaWO characteristics in hours for PzS batteries at 30 °C

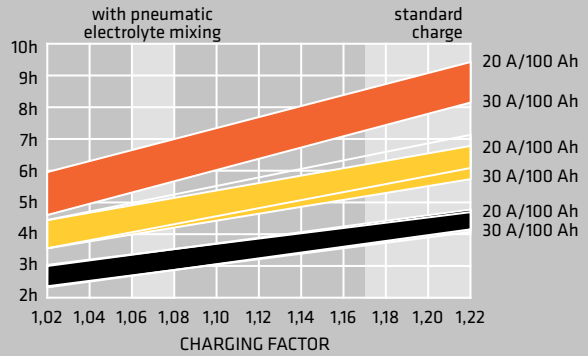

IUIa characteristic for flooded batteries

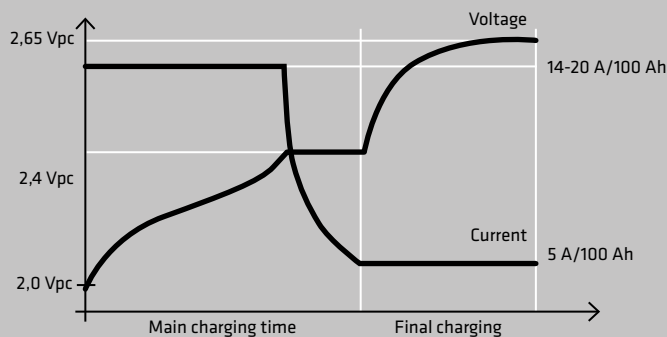

Charging times with IUIa characteristics in hours for PzS batteries at 30 °C

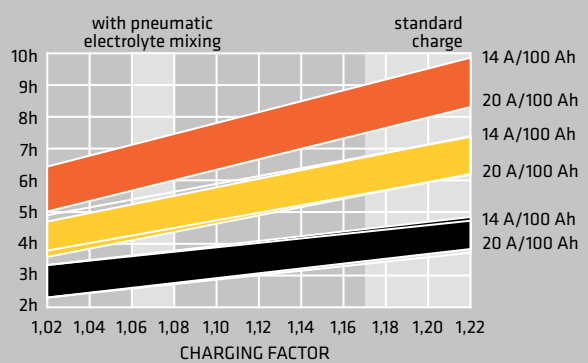

- 80 % DOD
- 60 % DOD
- 40 % DOD

Life as a function of % DOD for TAB traction DIN and BS cells

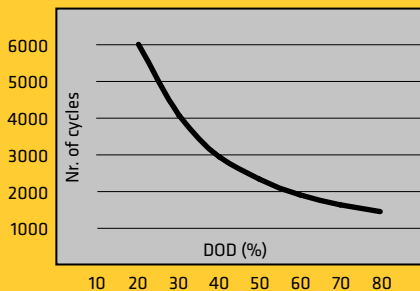

Expected Nr. of cycles of TAB traction DIN and BS batteries in dependence of Operating Temperature

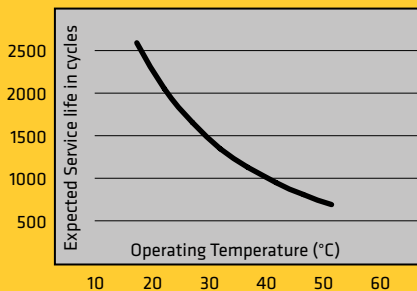

TAB PzS cells: Capacity C5 (%) as a function of the discharge rate

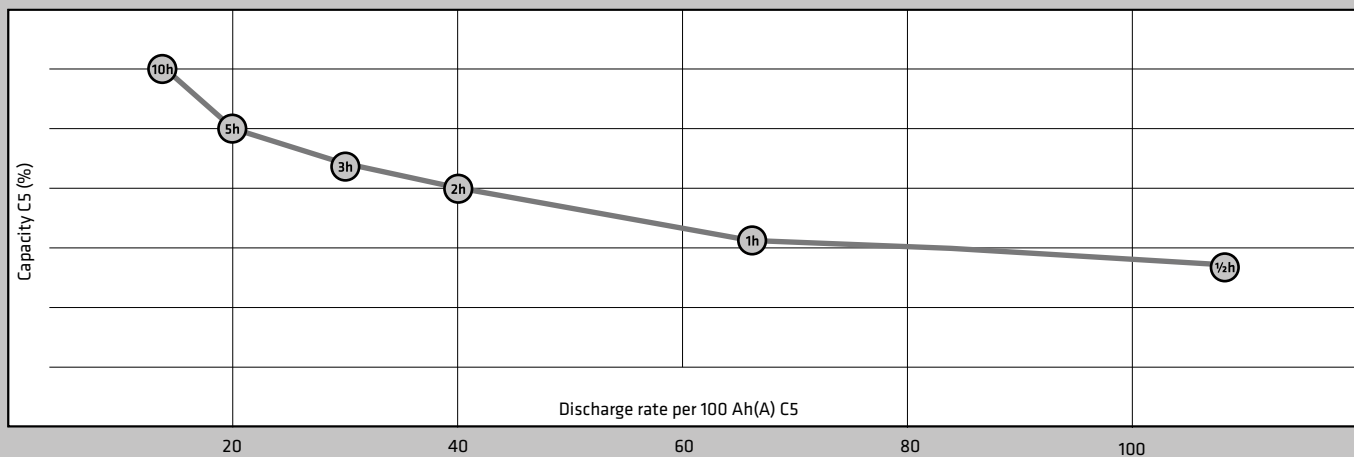

Voltage diagram of the PzS cell in dependence on discharging time

Vb = initial voltage (V), Vm = Medium voltage (V), Vs = final voltage (V)

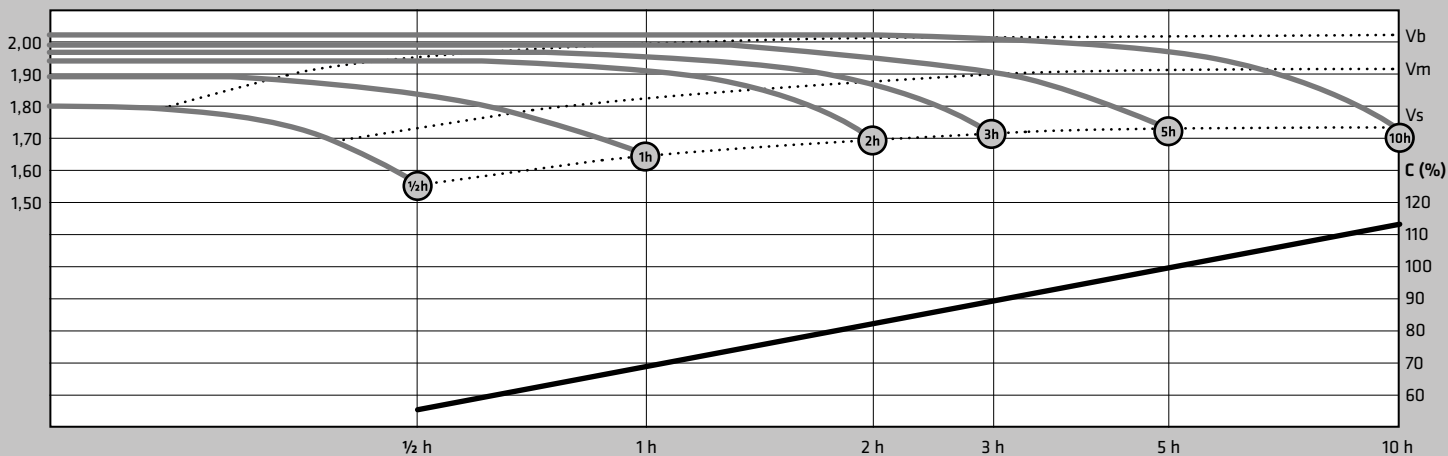

TAB PzS Cells: Relation Capacity vs. Temperature of electrolyte

● C5 (%) ● C1 (%)

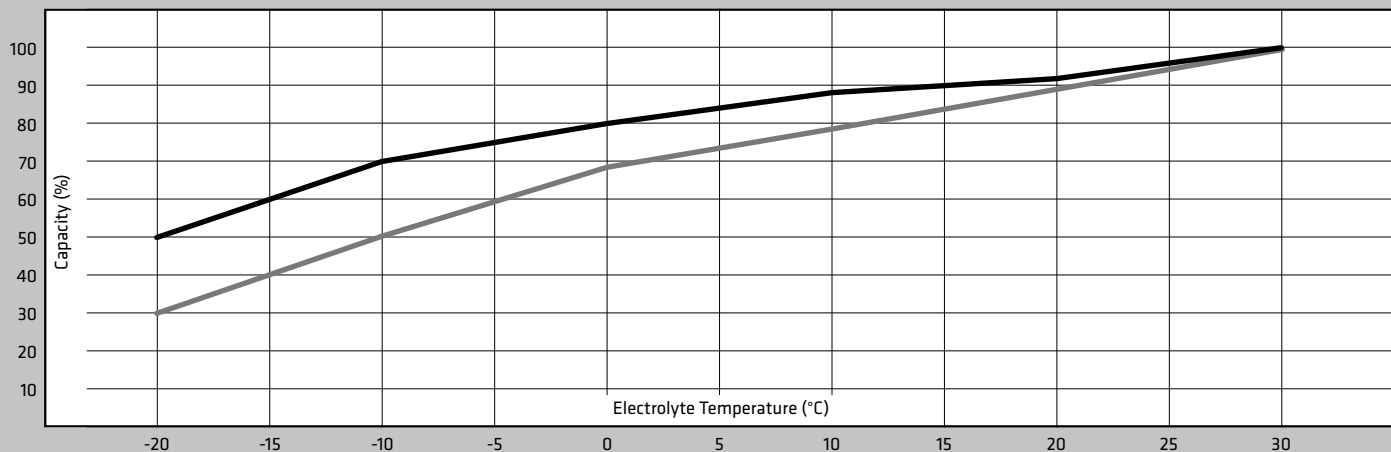

OPERATING INSTRUCTIONS

FOR TRACTION BATTERIES WITH POSITIVE TUBULAR PLATES

TYPE PzS, PzB

Nominal capacity C5:	see plate type
Nominal voltage:	2.0 V x No. of cells
Discharge current:	C5 / 5h
Nominal S.G. of electrolyte:	1,29 kg/l
Rated temperature:	30 °C

Batteries are produced in accordance with EN 60254-1.
Nominal capacity and electrolyte S.G. will be reached within the first 10 cycle.

1. COMMISSIONING

1.1 Filled and charged batteries:

- + The battery should be inspected to ensure it is in perfect physical condition.
- + The charger cables must be connected to ensure a good contact, taking care that the polarity is correct, otherwise battery, vehicle or charger could be damaged.
- + The specified torque loading for the polscrews of the charger cables and connectors is: 20–25 Nm
- + The level of the electrolyte must be checked. If it is below the pole bridge, it must first be topped up to this height with purified water (DIN 43530 part 4).
- + The battery is then charged as in item 2.2.
- + After charging, the electrolyte should be topped up to the specified level with purified water.

1.2 Dry charged (DC) batteries: See separate instructions!

2. OPERATION

EN 50272-3 is the standard which applies to the operation of traction batteries in industrial trucks.

- 2.1 Discharging:** Be sure that all breather holes are not sealed or covered. Electrical connections must only be made or broken in the open circuit condition to avoid sparks and explosion risks. To achieve the optimum life for the battery, operating discharges of more than 80 % of the rated capacity should be avoided (deep discharge). Discharged batteries must be recharged immediately and must not be left discharged. This also applies to partially discharged batteries.
- 2.2 Charging:** For charging only direct current must be used. All charging procedures in accordance with DIN 41773 and DIN 41774 are permitted. Connect the battery assigned to a charger suitable for the size of battery in order to avoid overloading of the electric cables and contacts, unacceptable gassing and the escape of electrolyte from the cells. In the gassing stage the current limits given in EN 50272-3 must not be exceeded. If the charger was not purchased together with the battery, it is best to have its suitability checked by the charger manufacturer's service department. When charging, proper provision for venting of the charging gases, accordingly to EN 50272-3 must be made. Battery container lids and the covers of battery compartments must be opened or removed. The vent plugs should stay on the cells and remain closed. With the charger switched off connect up the battery, ensuring that the polarity is correct (positive to positive, negative to negative). Now switch on the charger. When charging, the temperature of the electrolyte rises by about 10 °C, so charging should only begin if the electrolyte temperature is below 45 °C. The electrolyte temperature of batteries should be at least + 10 °C before charging otherwise a full charge will not be achieved. A charge is finished when the specific gravity of the electrolyte and the battery voltage have remained constant for two hours.
- 2.3 Equalising charge:** Equalising charges are used to safeguard the life of the battery and to maintain its capacity. They are necessary after deep discharges, repeated incomplete recharges and once a week in case of charges to an IU characteristic curve. Equalising charges are carried out following normal charging. The charging current must not exceed 5 A/100 Ah of rated capacity (end of charge - see point 2.2). The temperature may not exceed 55 °C!
- 2.4 Temperature:** An electrolyte temperature of 30 °C is specified as the rated temperature. Higher temperatures shorten the life of the battery, lower temperatures reduce the capacity available. 55 °C is the upper temperature limit and is not acceptable as an operating temperature.
- 2.5 Electrolyte:** The rated specific gravity (S. G.) of the electrolyte is related to a temperature of 30 °C and the nominal electrolyte level in the cell in fully charged condition. Higher temperatures reduce the specified gravity of the electrolyte, lower temperatures increase it. The temperature correction factor is - 0.0007 kg/l per °C, e.g. an electrolyte specific gravity of 1.28 kg/l at 45 °C corresponds to an S.G. of 1.29 kg/l at 30 °C. The electrolyte must conform to the purity regulations in DIN 43530 part 2.

3. MAINTENANCE

When charging the battery, one should record the time the battery is connected to the charger, the time upon disconnection, the temperature of the electrolyte at the end of the charge and the usage time of the battery. Record water refilling, repair, maintenance and other out-of-the-ordinary occurrences.

- 3.1 Daily:** After every discharge, charge the battery. Towards the end of charge the electrolyte level should be checked and if necessary topped up to the specified level with purified water. The electrolyte level must not fall below pole bridge.
- 3.1.1 Aquamatic water refilling system:** Optional water refilling system built on batteries is used to automatically maintain the nominal electrolyte levels. The battery should be topped up shortly before completion of a full charge with water and the conductance below 30 µS/cm. The battery should be connected to the filling system at least once a week. In multiple shift and warm ambient temperature operations it may be necessary to have shorter-daily topping up intervals. In winter, batteries fitted with Aquamatic system, should only be charged or refilled in a room temperature above 0 °C. For proper water pressure and optimal system operation, the water tank must be located from 2 to 6 m above the upper edge of the battery (0,2 to 0,6 bar). The top up process takes a few minutes and can vary according to the battery range. The valve in each cell allows the flow of water into cell and the float closes the valve when the correct water level has been reached. A flow indicator which is built into the water supply pipe to the battery, monitors the filling process. During filling the water flow causes the flow indicator to turn. When all the plugs are closed the indicator shows that the filling process is complete, the water supply to the battery should be turned off. Regularly clean integrated water filter! The system installed by the producer should not be modified in any way.
- 3.2 Weekly:** Visual inspection after recharging for signs of dirt and mechanical damage (point 4). If the battery is charged regularly with a IU characteristic curve, an equalising charge must be carried out (see point 2.3).
- 3.3 Monthly:** At the end of the charge the voltages of all cells or bloc batteries should be measured with the charger switched on and recorded. After the charging the specific gravity and the temperature of the electrolyte in all cells should be measured and recorded. If significant changes from earlier measurements or differences between the cells or bloc batteries are found, further testing and maintenance should be requested by the service department.
- 3.4 Annually:** Inter cell connectors torque load must be checked at least once per year, the insulation resistance of the truck and the battery must be checked by an electrical specialist. The insulation resistance of the battery thus determined must not be below a value of 50 Ω per Volt of nominal voltage in compliance with EN 50272-3. For batteries up to 20 V nominal voltage, the minimum value is 1000 Ω.
- 4. Care of the battery:** The battery should always be kept clean and dry to prevent tracking currents and to avoid self discharging and explosion risks. Cleaning must be done in accordance with the ZVEI code of practice "The Cleaning of Vehicle Traction batteries". Any liquid in the battery tray must be extracted and disposed of in the prescribed manner. Damage to the insulation of the tray should be repaired after cleaning to prevent tray corrosion and to ensure that the insulation value complies EN 50272-3.

5. STORAGE

If batteries are taken out of service for a longer period, they should be stored in the fully charged condition in a dry, frost-free room. To ensure the battery is always ready for use, a choice of charging methods can be made:

5.1 A monthly equalising charge as in point 2.3.

5.2 Float charging at a charging voltage of $2.27 V \times$ the number of cells. The storage time should be taken into account when considering the life of the battery.

6. ELECTROLYTE CIRCULATION SYSTEM

This optional system is recommended for heavy duty use, short charge times, boost or opportunity charging and in high ambient temperatures. The system reduces water consumption, working temperatures and a charge factor, prevents the stratification of the electrolyte and reduces charging time.

The principle of the electrolyte circulation system is based on pumping of air into each battery cell which creates a circulating air stream inside the cell box. The charge plug with integrated air supply automatically supplies air to the battery pipe system after connecting to the charger designed for electrolyte circulation. For optimized operation the pump should supply pressure around 0,2 bar and air flow 60 liters/cell, hour. Before initial operation of battery with electrolyte circulation system make a visual examination of the electrolyte surfaces of all cells for movement and rising air bubbles during running the air pump. At least once a year the pump air filter must be changed. In working areas with high level of air pollution, the filter should be checked and replaced more frequently in order to assure proper air circulation.

7. MALFUNCTIONS

If malfunctions are found on the battery or the charger, suppliers service department should be called in without delay. The measurements taken in point 3.3 will facilitate fault finding and their elimination.

8. TRANSPORT

Batteries, wet, filled with acid, require transport under demands of European Agreement concerning the international carriage of dangerous goods (ADR and RID).

ADR special provision No. 598:

New batteries are not subject to the requirements of ADR when:

- + they are secured in such a way that they can not slip, fall or be damaged;
- + they are provided with carrying devices, unless they are suitably stacked, e.g. on pallets;
- + there are no dangerous traces of alkalis or acids on the outside;
- + they are protected against short circuits.

IGNORING THE INSTRUCTIONS, REPAIR WITH NON-ORIGINAL PARTS WILL RENDER WITH WARRANTY VOID.

SPENT BATTERIES MUST BE COLLECTED SEPARATELY AND RECYCLED.

INSTRUCTIONS FOR THE SAFE HANDLING OF LEAD-ACID BATTERIES

EUROBAT CUSTOMER CARE PROGRAM

1. HAZARDOUS SUBSTANCES

CAS no.	Description	Content [% of weight]	R-phrases
7439-92-1	Lead Grid metallic lead, lead alloys with possible traces of additives	~ 33	
7439-92-1	Active Mass Battery Oxide, inorganic lead compounds	~ 32	R61-20/22-33 62-52/53
7664-93-9	Electrolyte diluted sulphuric acid with additives	~ 33	R35

2. POTENTIAL HAZARDS

No hazards occur during the normal operation of a Lead Acid Battery as it is described in the instructions for use that are provided with the Battery. Lead-acid Batteries have three significant characteristics:

- + They contain an electrolyte which contains diluted sulphuric acid. Sulphuric acid may cause severe chemical burns.
- + During the charging process or during operation they might develop hydrogen gas and oxygen, which under certain circumstances may result in an explosive mixture.
- + They can contain a considerable amount of energy, which may be a source of high electrical current and a severe electrical shock in the event of a short circuit.

Standard EN 50272-2 includes safety requirements for batteries. The Batteries have to be marked with the symbols listed under item 14.

3. FIRST AID MEASURES

This information is of relevance only if the Battery is broken and this results in a direct contact with the ingredients.

3.1 General

Electrolyte (diluted sulphuric acid): sulphuric acid acts corrosively and damages skin
Lead compounds: lead compounds are classified as toxic for reproduction (if swallowed)

3.2 Electrolyte (Sulphuric acid)

after skin contact: rinse with water, remove and wash wetted clothing
after inhalation of acid mist: inhale fresh air, seek advice of a medical doctor
after contact with the eyes: rinse under running water for several minutes, seek advice of a medical doctor
after swallowing: drink lot of water immediately, swallow activated carbon, do not induce vomiting, seek advice of a medical doctor

3.3 Lead compounds

after skin contact: clean with water and soap
after inhalation: inhale fresh air, seek advice of a medical doctor
after contact with the eyes: rinse under running water for several minutes, seek advice of a medical doctor
after swallowing: wash mouth with water, seek advice of a medical doctor

4. FIRE FIGHTING MEASURES

Suitable fire extinguishing agents: CO₂ or dry powder extinguishing agents
Unsuitable fire extinguishing agents: Water, if the battery voltage is above 120 V
Special protective equipment: Protective goggles, respiratory protective equipment, acid protective equipment, acid-proof clothing in case of

larger stationary battery plants or where larger quantities are stored

5. MEASURES TO BE TAKEN IN CASE OF ACCIDENTAL RELEASE

This information is of relevance only if the battery is broken and the ingredients are released.
In the case of spillage, use a bonding agent, such as sand, to absorb spilt acid: use lime / sodium carbonate for neutralisation; dispose of with due regard to the official local regulations; do not allow penetration into the sewage system, into earth or water bodies.

6. HANDLING AND STORAGE

Store under roof in cool ambient - charged lead-acid batteries do not freeze up to -50°C; prevent short circuits. Seek agreement local water authorities in case of larger quantities of batteries to be stored. If batteries have to be stored, it is imperative that the instructions for use are observed.

7. EXPOSURE LIMITS AND PERSONAL PROTECTIVE EQUIPMENT

7.1 Lead and Lead compounds

No exposure to lead and lead-containing battery paste during normal conditions of use

7.2 Electrolyte (Sulphuric Acid)

Exposure to sulphuric acid and acid mist might occur during filling and charging.

Threshold value in workplace: occupational exposure limits for sulphuric acid mist are regulated on a national basis.

Hazard symbol: C, corrosive

Personal protective equipment: Protective goggles, rubber or PVC gloves, acid-resistant clothing, safety boots.

CAS-No: 7664-93-9

R-phrases: R-35 Causes severe chemical burns

S-phrases: 3-2 Keep out of reach of children

S-16 Keep away from sparks or naked flame, No smoking

S-26 In case of contact with eyes rinse immediately with plenty

of water and seek medical advice

S-45 In case of accident or if you feel unwell seek medical advice immediately (show the label where possible).

8. PHYSICAL AND CHEMICAL PROPERTIES

	Lead and Lead compounds	Electrolyte [diluted sulphuric acid, 30 to 38.5%]
APPEARANCE		
form:	solid	liquid
colour:	grey	colourless
odour:	odourless	odourless
SAFETY-RELATED DATA		
solidification point:	327 °C	-35 to -60 °C
boiling point:	1740 °C	approx. 108 to 114 °C
solubility in water:	very low (0.15 mg/l)	complete
density (20°C):	11.35 g/cm ³	1.2 to 1.3 g/cm ³
vapour pressure (20°C):	N.A.	N.A.

Lead and Lead compounds used in Lead-Acid batteries are poorly soluble in water, Lead can be dissolved in an acidic or alkaline environment only.

9. STABILITY AND REACTIVITY (sulphuric acid, 30 - 38,5%)

- + Corrosive, non-flammable liquid
- + Thermal decomposition at 338 °C
- + Destroys organic materials such as cardboard, wood, textiles
- + Reacts with metals, producing hydrogen
- + Vigorous reactions on contact with sodium hydroxide and alkalis

10. DATA ON THE ECOLOGICAL OF THE CONSTITUENTS

10.1 Electrolyte (diluted sulphuric acid):

Sulphuric Acid is intensely corrosive to skin and mucous membranes: the inhalation of mists may cause damage to the respiratory tract.

10.2 Lead and Lead compounds

Lead and its compounds used in a Lead Acid Battery may cause damage to the blood, nerves and kidneys when ingested. The lead contained in the active material is classified as toxic for reproduction.

11. DATA ON THE ECOLOGY OF THE CONSTITUENTS

This information is of relevance if the battery is broken and the ingredients are released to the environment.

11.1 Electrolyte (diluted sulphuric acid)

In order to avoid damage to the sewage system, the acid has to be neutralised by means of lime or sodium carbonate before disposal. Ecological damage is possible by change of pH. The electrolyte solution reacts with water and organic substances, causing damage to flora and fauna. The electrolyte may also contain soluble components of lead that can be toxic to aquatic environments

11.2 Lead and Lead compounds

Lead can be dissolved in an acidic or alkaline environment. Chemical and physical treatment is required for the elimination from water. Waste water containing lead must not be disposed of in an untreated condition.

12. RECYCLING INFORMATION

Spent lead-acid batteries are subject to regulation of the EU Battery Directive and its adoptions into national legislation on the composition and end-of-life management of batteries. Spent Lead-Acid batteries are recycled in lead refineries (secondary lead smelters). The components of a spent Lead-Acid battery are recycled or re-processed. At the points of sale, the manufacturers and importers of batteries, respectively the metal dealers take back spent batteries, and render them to the secondary lead smelters for processing. To simplify the collection and recycling or re-processing process, spent Lead-Acid batteries must not be mixed with other batteries. By no means may the electrolyte (diluted sulphuric acid) be emptied in an inexperienced manner. This process is to be carried out by the processing companies only.

13. TRANSPORT REGULATION
13.1 Flooded Lead-Acid batteries:
Land Transport (ADP/RID)

- + LINI number: UN2794
- + Classification ADR/RID: Class 8
- + Proper Shipping Name: BATTERIES, WET, FILLED WITH ACID electric storage
- + Packing Group ADR: not assigned
- + Label required: Corrosive
- + ADR/RID: New and spent batteries are exempt from all ADR/RID (special provision 598).

Sea Transport (IMDG Code)
(on account of the differences between products supplied by various manufacturers, the supplier should be consulted.)

- + Classification: Class 8
- + UN number: UN2794
- + Proper Shipping Name: BATTERIES, WET, FILLED WITH ACID electric storage
- + Packing Group: III
- + EmS: F-A, S-B
- + Label required: Corrosive

Air Transport (LATA-DGR)

- + Classification: Class 8
- + LIN number: UN2794
- + Proper Shipping Name: BATTERIES, WET, FILLED WITH ACID electric storage
- + Packing Group: III
- + Label required: Corrosive

13.2 VRLA batteries only:
Land Transport (ADR/RID, U.S. DOT)

- + UN number: UN2800
- + Classification ADR/RID: Class 8
- + Proper Shipping Name: BATTERIES, WET, NION SPILLABLE electric storage
- + Packing Group ADR: not assigned
- + Label required: Corrosive
- + ADP/RID: New and spent batteries are exempt from all ADR/RID (spec. provision 598).

Sea Transport (IMDG Code)

- + UN number: UN2800
- + Classification: Class 8
- + Proper Shipping Name: BATTERIES, WET, NON SPILLABLE electric storage
- + Packing Group: III
- + EmS: F-A, S-B
- + Label required: Corrosive
- + If non-spillable batteries meet the Special Provision 238, they are exempted from all IMDG codes provided that the batteries terminals are protected against short circuits.

Air Transport (IATA-DGR)

- + UN WI UN2000
- + Classification: Class 8
- + Proper Shipping Name: BATTERIES, WET, NON SPILLABLE electric storage
- + Packing Group: III
- + Label required: Corrosive
- + If non-spillable batteries meet the Special Provision A67, they are exempted from all IATA DGR codes provided that the batteries terminals are protected against short circuits.

14. REGULATORY INFORMATION

In accordance with EU Battery Directive 2006/66/EC and the respective national legislation, Lead-Acid batteries have to be marked by a crossed out dust bin with the chemical symbol for lead shown below, together with the ISO return/recycling symbol.

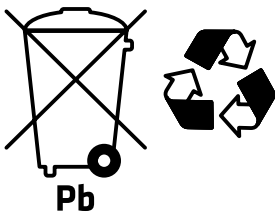

In addition Lead-Acid batteries have to be labelled with the hazard symbols described below:



OBSERVE OPERATING INSTRUCTIONS



KEEP AWAY FROM CHILDREN



EXPLOSIVE GAS MIXTURE



WEAR SAFETY GOOGLES



OBSERVE OPERATING INSTRUCTIONS



CORROSIVE

Labelling might vary due to application and dimension of the Battery. The manufacturer, respectively the importer of the batteries shall be responsible for placing the symbols (a minimum size is specified). In addition, consumer/user information on the significance of the symbols may be attached.

15. OTHER INFORMATION

Products such as Batteries are not in the scope of regulation which require the publication of an EU REACH regulation (1907/2008/EC-Safety Data Sheet (911155/EEC).

The information given above is provided in good faith based on existing knowledge and does not constitute an assurance of safety under all conditions. It is the user's responsibility to observe all laws and regulations applicable for storage, use, maintenance or disposal of the product. If there are any queries, the supplier should be consulted.

However, this shall not constitute a guarantee for any specific product features and shall not establish a legally valid contractual relationship.

GEL BATTERIES APPLICATIONS

VRLA cells in good quality are a perfect product for many motive power applications. The GEL technology is particular suitable for cycling applications and the absolute maintenance free design brings many advantages for the end user. However, as a matter of technology and design VRLA products are not as robust as flooded systems and have some restrictions in applications. Whereby any light to medium applications is most ideal for this batteries, using PzV batteries in heavy applications need some precautions in term of temperature control and battery management.



Category I Light application	Category II Medium application	Category III Heavy application
FLOODED		
VRLA		

We recommend following discharge rates:

80 % DOD up to 14,4 kWh:

24V max. 600 Ah 36V max. 400 Ah 48V max. 300 Ah

70% DOD up to 20,0 kWh:

24V max. 840 Ah 36V max. 560 Ah 48V max. 420 Ah

For all 72/80V batteries and batteries > 20 kWh please consult application engineering.

TAB Traction GEL batteries (PzV, PzVB) C5 capacity during life

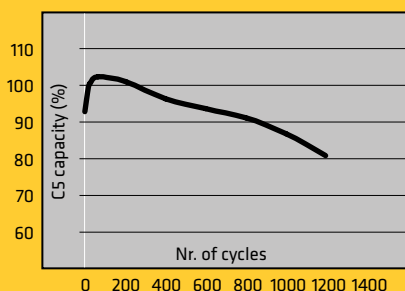

Discharging voltage curves for TAB - GEL traction PzV and PzVB cells

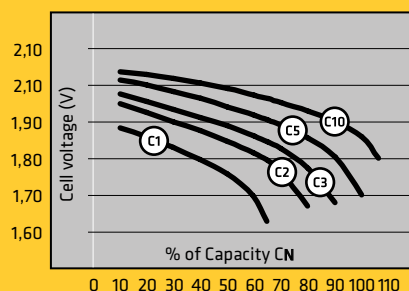

Life in cycles as a function of % DOD for TAB - PzV and PzVB cells

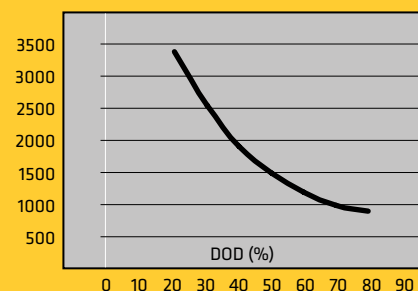

CHARGING OF TAB PzV AND PzVB TRACTION CELLS

VRLA batteries require a regulated charging characteristic. It is important that the charger meets the needed standards for GEL batteries in terms of charging regime, ripple current and all safety issues. Only from the battery manufacturer recommended and approved chargers should be used.

CHARGING REGIME

The charging regime is an IUI characteristic. The first constant phase ends when the cell voltage reaches 2,35 V and the charger switch to a constant voltage phase of 2,35 V per cell. The second I (I2) phase begins when the current dropped down to 1,3 to 1,5 A per 100 Ah of battery capacity. The main charging time (T1 and T2) can take max. 12 hours; the T3 time depends of the main charging time and can vary from 1 hour to 4 hour max. (1h < T3 = T2 + T1 < 4h)

These settings are applied for operation temperatures between 20 °C and 40 °C. Higher operation (battery) temperatures may require a voltage adjustment and need a temperature controlled charging regime. Please contact application engineering.

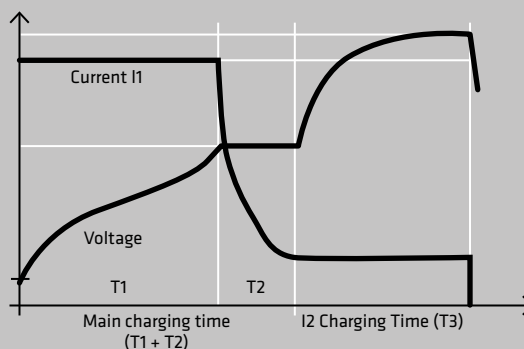

Charging data:

Charging time: 12-16 hours
I1 current: 13-15 A (for 100 Ah cell capacity)
U phase: 2,35 V per cell (30 °C)
I2 current: 1,2-1,5 A (for 100 Ah cell capacity)
U end: max. 2,80V

OPERATING INSTRUCTIONS

FOR MAINTENANCE FREE TRACTION BATTERIES

WITH POSITIVE TUBULAR PLATES TYPE PzV AND PzVB

Nominal capacity C5:	see plate type	Final discharge voltage, 80 % discharge:	1,89 V/cell
Nominal voltage:	2.0 V x No. of cells	Final discharge voltage, 60 % discharge:	1,96 V/cell
Discharge current:	C5 / 5h	Rated temperature:	30 °C

PzV batteries are valve-regulated batteries with an immobilized electrolyte, where water refilling is not needed during the whole battery life. Instead of a vent plug, valves are used. It is strictly prohibited to open them since they will be destroyed. When using PzV and PzVB valve-regulated lead-acid batteries, apply to the same safety requirements as for vented cells to protect against electric current hazards, explosion of electrolytic gas, in case of a cell container damage and to protect from electrolyte corrosion.

1. COMMISSIONING

The battery should be inspected to ensure it is in perfect physical condition. The battery and charger cables must have a good contact to terminals, check the polarity is correct. Otherwise battery, vehicle or charger could be destroyed. The battery has to be charged according to item 2.2.

The specified torque loading for the pole screws of the charger cables and connectors is: **20-25 Nm**

2. OPERATION

EN 50272-3 is the standard which applies to the operation traction batteries in industrial truck.

2.1 Discharging

Ventilation openings must not be sealed or covered. Electrical connection (e.g. plugs) must only be made or broken in the open circuit condition. To achieve the optimum life for the battery we recommend discharge up to 60% DOD. Deep discharges reduce the battery life considerably and should be avoided. Discharged batteries must be recharged immediately and must not be left discharged. This also applies to partially discharged batteries.

TAB PzV and PzVB batteries can be used in normal duty applications for one cycle of charge and discharge per twenty-four (24) hour day and a maximum 6 days per week.

2.2 Charging

Only direct current must be used for charging. A full charge shall be carried out every working day. The charging procedures in accordance with DIN 41773 and DIN 41774 must only be applied and the manufacturer approved modifications. Only connect the battery assigned to a charger, suitable for the size of battery, in order to avoid overloading of the electric cables and contacts, unacceptable gassing from the cells. PzV cells have a low gas emission. When charging, proper provision must be made for venting of the charging gases, accordingly to EN 50272-3 must be made. Battery container lids and covers of battery must not be opened or removed. With the charger switches off connect up the battery, ensuring that the polarity is correct (positive to positive, negative to negative). Now switch on the charger. When charging the temperature of the battery rises by about 15 °C so charging should only begin if the battery temperature is below 35 °C. The battery temperature should be at least + 15 °C before charging otherwise a full charge will not be achieved. A charge is finished when the battery voltage have remained constant for two hours. Is the temperature a longer time higher than 40 °C or lower than 15 °C, so the chargers need a temperature regulated voltage. The correction factor $-0,005V/cell/K$ is in accordance with EN 50272-3 must not be exceeded.

2.3 Equalising charge

Equalizing charges are used to safeguard the life of the battery and to maintain its capacity. They are necessary after deep discharges, repeated incomplete recharges and once a week in case of charges to an IU characteristic curve. Watch the temperature!

2.4 Temperature

A battery temperature of 30 °C is specified as the rated temperature. Higher temperatures shorten the life of the battery, lower temperatures reduce the capacity available. 45 °C is the upper temperature limit and is not acceptable as an operating temperature.

2.5 Electrolyte

The electrolyte is immobilized in a gel. The density of the electrolyte can not be measured.

3. MAINTENANCE

By each charging the following data should be recorded: time of connecting battery to the charger, time of disconnection and time of start using the battery. Service, maintenance and other special cases should also be recorded. Don't refill water! Do not remove the safety valve from cell!

3.1 Daily

Charge the battery immediately after every discharge.

3.2 Weekly

Visual inspection after recharging for signs of dirt and mechanical damage. Check that the plugs and sockets are in good condition.

3.3 Quarterly

After the end of the charge and a rest time of 5 h following should be measured and recorded:

- + the voltage of battery
- + the voltage of every cells

If significant changes from earlier measurements or differences between the cells or block batteries are found, further testing and maintenance by the service department should be requested.

3.4 Annually

Intercell connectors' torque load must be checked at least once per year. In accordance with EN 50273-3 at least once per year, the insulation resistance of the truck and the battery must be checked by an electrical specialist. The tests on the insulation resistance of the battery must be conducted in accordance with EN 60254-1. The insulation resistance of the battery thus determined must not be below a value of 50 Ω per Volt of nominal voltage, in compliance with EN 50272-3. For batteries up to 20 V nominal voltage the minimum value is 1000 Ω.

4. CARE OF THE BATTERY

The battery should always be kept clean and dry to prevent tracking currents to avoid self discharging and explosion risks. Cleaning must be done in accordance with the ZVEI code of practice "The Cleaning of Vehicle Traction batteries". Any liquid in the battery tray must be extracted and disposed of in the prescribed manner. Damage to the insulation of the tray should be repaired after cleaning to prevent tray corrosion and to ensure that the insulation value complies EN 50272-3.

5. STORAGE

If batteries are taken out of service for a lengthy period they should be stored in the fully charged condition in a dry, frost-free room. To ensure the battery is always ready for use a choice of charging methods can be made:

5.1 A quarterly full charging like charge as in point 2.2.

5.2 Float charging at a charging voltage of $2.25 V \times$ the number of cells.

The storage time should be taken into account when considering the life of the battery.

6. MALFUNCTIONS

If malfunctions are found on the battery or the charger suppliers service department should be called in without delay. The measurements taken in point 3.3 will facilitate fault finding and their elimination.

SAFETY DATA SHEET ON ACCUMULATOR ACID (DILUTED SULPHURIC ACID) IN COMPLIANCE WITH EC DIRECTIVE 91/155/EU

1. SUBSTANCE

Formulation and company name

Data on the product: diluted sulphuric acid (1,22 . . . 1,29 kg/l)
Trade name: accumulator acid
Data on the manufacturer: . . .
Telephone: . . .
Facsimile: . . .

2. COMPOSITION

Data on the constituents

Chemical characteristics:
Sulphuric acid: 30 . . . 38,5%ig, density 1,22 . . . 1,29kg/l
CAS-Number: 7664-93-9
EU-Number: 016-020-00-8
UN-Number: 2796
EINECS-Number: 231-639-5

3. POTENTIAL HAZARDS

Diluted sulphuric acid may cause severe acid burns.

4. FIRST-AID MEASURES

General instructions: Remove soiled, wetted clothing immediately.
after contact to skin: Rinse with a lot of water immediately after contact to skin.
after inhalation of acid mist: Inhale fresh air. Seek the advice of a doctor.
after contact with the eyes: Rinse under running water for several minutes. Seek the advice of a doctor.
after swallowing: Drink a lot of water immediately, and swallow activated carbon. Seek the advice of a doctor.

5. FIRE-FIGHTING MEASURES

Suitable extinguishing agents in case of surrounding fires: CO₂ and solid existing agent.

6. MEASURES TO BE TAKEN IN CASE OF UNINTENTIONAL RELEASE

Cleaning / take-up procedures: Use a bonding agent, such as sand, to absorb spilt acid; use lime / sodium carbonate for neutralisation, dispose with due regard to the official local regulations.

7. HANDLING AND STORAGE

Store frost-free under roof. Seek agreement with local water authorities in case of larger quantities. Observe VAWS.

8. EXPOSURE LIMITS AND PERSONAL PROTECTIVE EQUIPMENT

Possible exposure caused by sulphuric acid and acid mist during filling and charging:
Threshold value on workplace: 0,1 mg/m³ (0,5 mg/m³ at the lead battery production*)
Personal protective equipment: Rubber, PVC gloves, acid-proof goggles, acid proof clothing safety boots.

9. PHYSICAL AND CHEMICAL PROPERTIES

APPEARANCE

form: liquid
colour: colourless
odour: odourless

SAFETY-RELATED DATA

solidification point: - 35 . . . - 60 °C
boiling point: approx. 108 . . . 114 °C
Solubility in water: complete
flash point: N.A.
ignition temperature: N.A.
lower explosive limit: N.A.
density (20 °C): (1.2 - 1.3) g/cm³
vapour pressure (20 °C): 14.6 mbar
bulk density: N.A.
pH value: < 1 (at 20 °C)
dynamic viscosity: approx. 2.8 mPa . s (at 20 °C)

10. STABILITY AND REACTIVITY OF THE SULPHURIC ACID (30 . . . 38.5 %)

- + Corrosive, inflammable liquid.
- + Thermal decomposition at 338 °C.
- + Destroys organic materials, such as cardboard, wood, textiles.
- + Reacts with metals producing hydrogen.
- + Vigorous reactions with lyes and alkalis.

11. DATA ON THE TOXICOLOGY OF THE CONSTITUENTS

+ acts intensely caustic on skin and mucous membranes, in low concentration already. The inhalation of mists may cause damage to the respiratory tract.

12. DATA ON THE ECOLOGY OF THE CONSTITUENTS

+ Water-polluting liquid within the meaning of the German Water Resources Act.
+ Water pollution class: 1 (mildly water polluting).
+ In order to avoid damage to the sewage system, the acid has to be neutralised by means of lime or sodium carbonate before disposal.
+ Ecological damage is possible by change of pH.

13. INSTRUCTIONS FOR PROCESSING / DISPOSAL

+ The batteries have to be processed /disposed of with regard to the official local regulations.

14. TRANSPORT REGULATIONS

Land transport: ADR chapter 3.2, UN 2796 / RID chapter 3.2, UN 2796
Description of the goods: Battery, fluid, Acid
Danger number: 80
UN number: 2796
Sea transport: IMDG-Code chapter 3.2, UN 2796
Air transport: IATA-DGR chapter 3.2, sulphuric acid
Other data: Dispatch per mail service impermissible

15. REGULATIONS

Marking according to	German Regulations on Hazardous Materials	Identification requirement
Danger symbol		C, corrosive
R-phrases	35	Causes severe burns.
S-phrases	1 / 2	Keep locked up and out of reach of children.
	26	In case of contact with eyes rinse immediately with plenty of water and seek medical advice.
	30	Never add water to this product (applies for concentrated acid only, and not for refilling the battery with water).
	45	In case of accident or if you feel unwell seek medical advice immediately (show the label where possible).

National regulations:

Water pollution class: 1 (list material)
Other regulations: To be observed in case of storage: German Water Resources Act

16. MISCELLANEOUS DATA

The data rendered above are based on today's knowledge, and do not constitute an assurance of properties. Existing laws and regulations have to be observed by the recipient of the product in own responsibility.

SAFETY REQUIREMENTS AND TIPS ACCORDING TO EN 50272-3



OBSERVE OPERATING INSTRUCTIONS

AND AFFIX CLOSE WITHIN SIGHT OF THE BATTERY!
WORK ON BATTERIES ONLY UNDER INSTRUCTIONS OF SKILLED PERSONNEL!



SMOKING PROHIBITED!

DO NOT EXPOSE BATTERY TO OPEN FLAME, GLOWING FIRE OR SPARKS AS
EXPLOSION AND FIRE HAZARD EXISTS!

- + Do not forget to switch the charger off before connecting or disconnecting a battery.
- + Avoid sparks caused by accidental short circuits.
- + Discharge any possible static electricity from clothes by touching an earth connected part before any work on a battery.



WHEN WORKING ON BATTERIES

WEAR PROTECTIVE GOGGLES AND CLOTHING!



EXPLOSION AND FIRE HAZARD!

AVOID SHORT CIRCUITS! CAUTION! METAL PARTS OF THE BATTERY CELLS ARE ALWAYS LIVE,
THEREFORE DO NOT PLACE ITEMS OR TOOLS ON THE BATTERY!

- + Adequate ventilation MUST be provided (acc. to EN/IEC 50272/3).
- + Do maintain the proper electrolyte (acid) level by frequent additions of water.
- + People charged with caring for or operating batteries should not wear any metal jewelry. Remove metallic personal adornments from the hands and wrists (like watches, rings, ...) that might come in contact with the battery terminals.
- + Discharge any possible static electricity from clothes by touching an earth connected part before any work on a battery.
- + Cleaning of the battery must be carried out with a damp cotton cloth (no man-made synthetic fibres).
- + Avoid sparks caused by accidental short circuits.
- + Always use tools with insulated handles.
- + Do not forget to switch the charger off before connecting or disconnecting a battery.
- + Ensure connections are tight before switching on battery.
- + Battery container lids and the covers of the battery must be opened or removed during charging.
- + Some charger components may produce sparks. Therefore min distance of the charger from the battery must be 0,6 meter.



ELECTROLYTE IS STRONGLY CORROSIVE!

- + Always handle batteries with care and keep upright.
- + Do not overfill batteries.
- + Always keep away from children.



MONOBLOCK BATTERIES (CELLS) ARE VERY HEAVY!

ENSURE SECURE INSTALLATION!
ONLY USE SUITABLE TRANSPORT EQUIPMENT!



DANGEROUS VOLTAGE!

- + People charged with caring for or operating batteries should not wear any metal jewelry. Remove metallic personal adornments from the hands and wrists (like watches, rings, ...) that might come in contact with the battery terminals.



ACID SPLASHES IN THE EYES OR ON THE SKIN MUST BE WASHED OUT OR OFF WITH PLENTY OF WATER THEN SEE A DOCTOR IMMEDIATELY.

ACID ON CLOTHING SHOULD BE WASHED OUT WITH WATER!



ENERGY IN MOTION

GREAT QUALITY, EXCELLENT SERVICE
AND ENVIRONMENTAL AWARENESS



TAB d.d.
Polena 6, SI-Mežica 2392, Slovenia

Sales department:
T: +386 (0)2 8702 320 / +386 (0)2 8702 300
F: +386 (0)2 8702 335

Service department:
T: +386 (0)2 8700 211
F: +386 (0)2 8700 234

www.tab.si

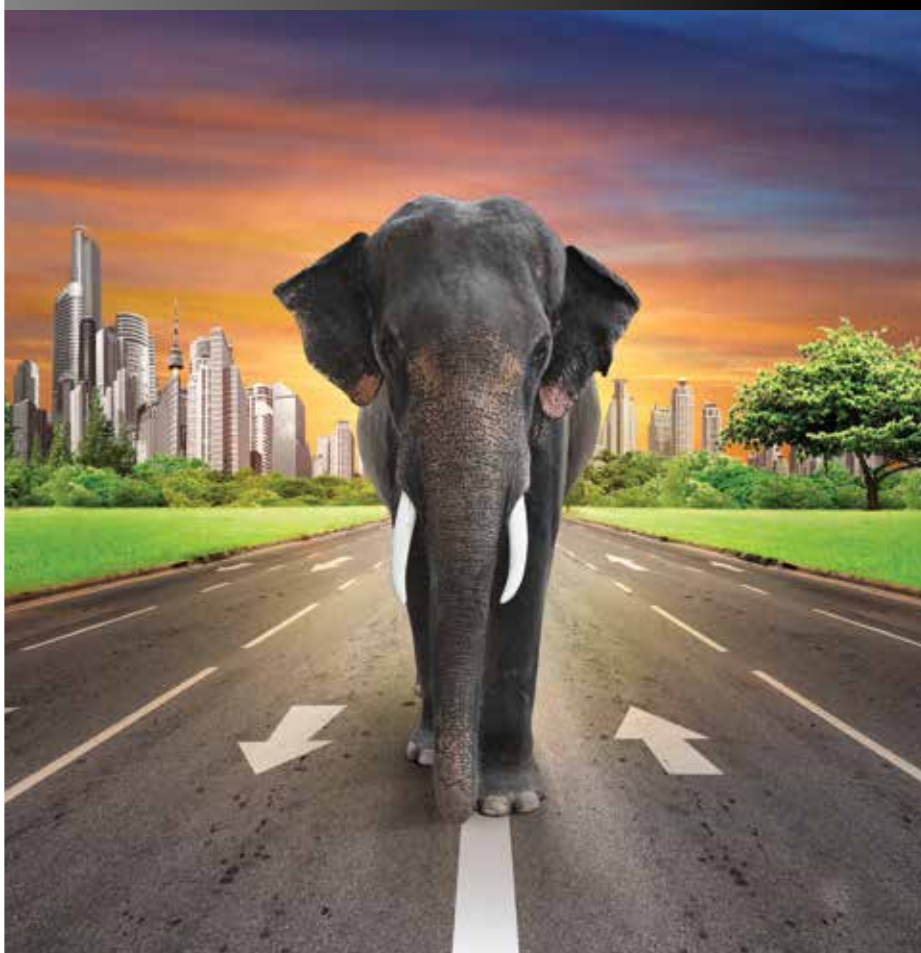

TAB 